

# JetBelt™

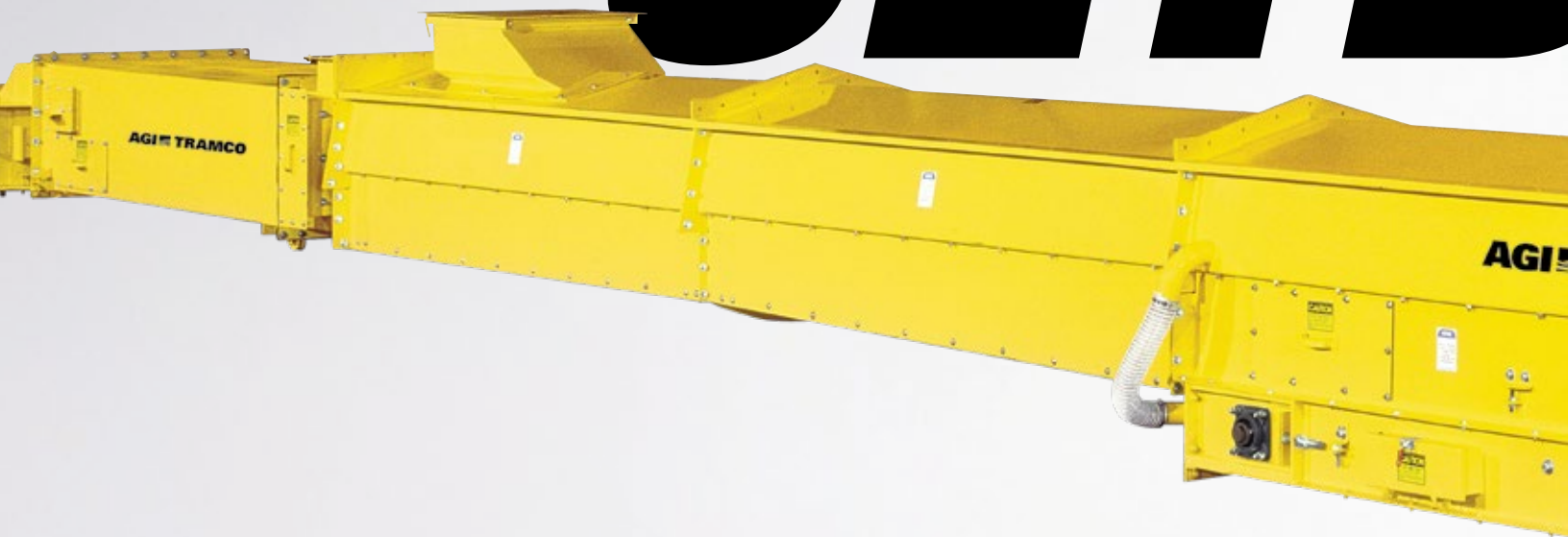

# JETB



THE HIGHEST PERFORMANCE  
AT THE BEST VALUE!

Designed & Engineered for Versatility.

# BELT™

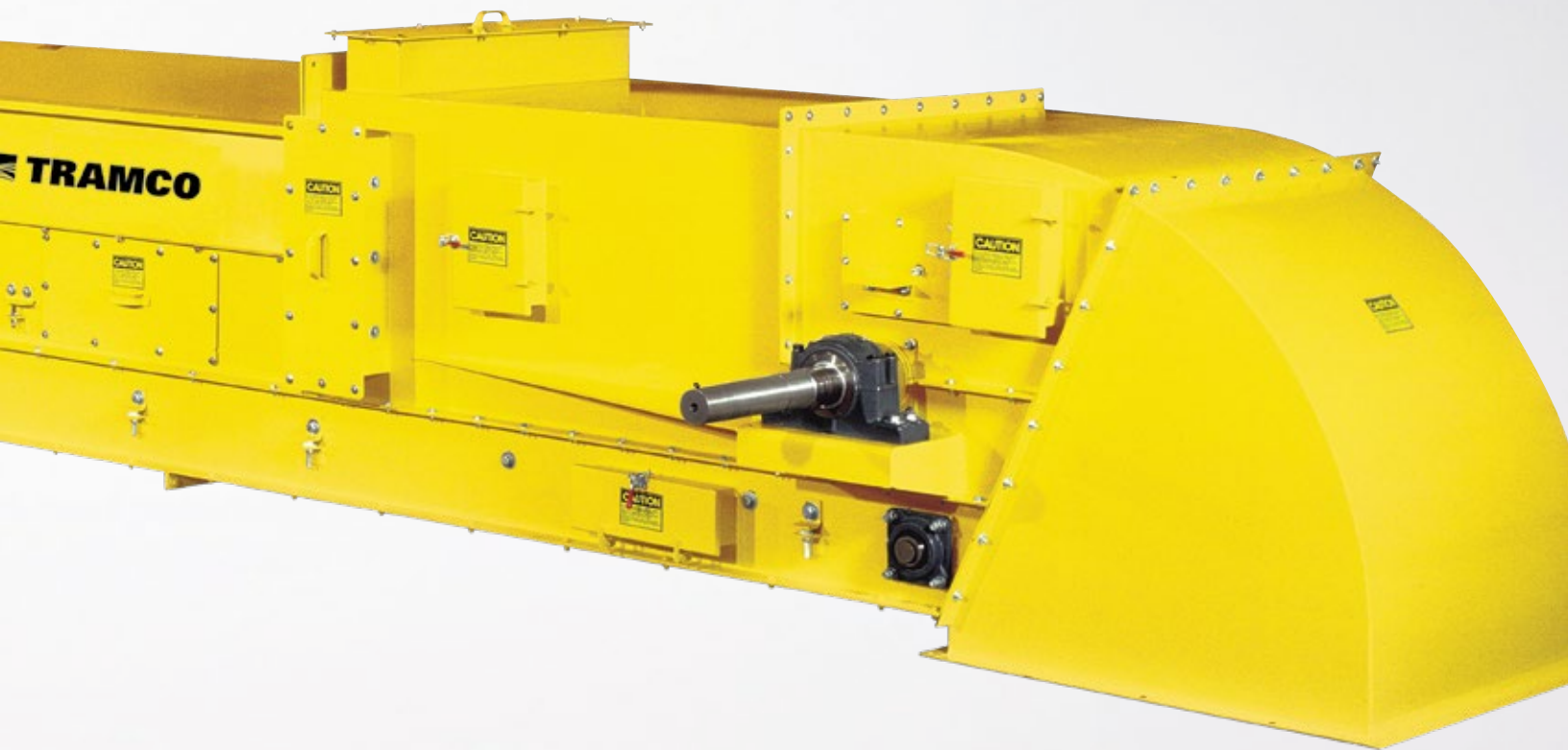

# LOOK, NO BEARINGS... JUST A CUSHION OF AIR!

The TRAMCO JetBelt™ is designed for free flowing products in all types of industries. You will find it is a good choice when dust containment is important. It is an efficient system requiring less horsepower and no idlers in the material carrying or empty return pan regardless of the conveying distance. The head section is split making removal of shaft and pulley assemblies easy. The tail section has bolt-on covers and a slot for pulley removal.

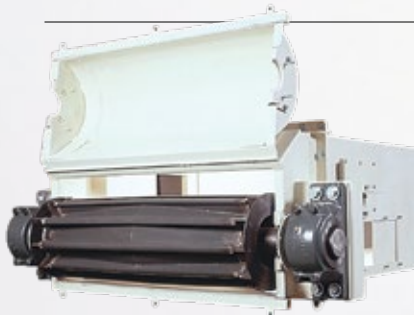
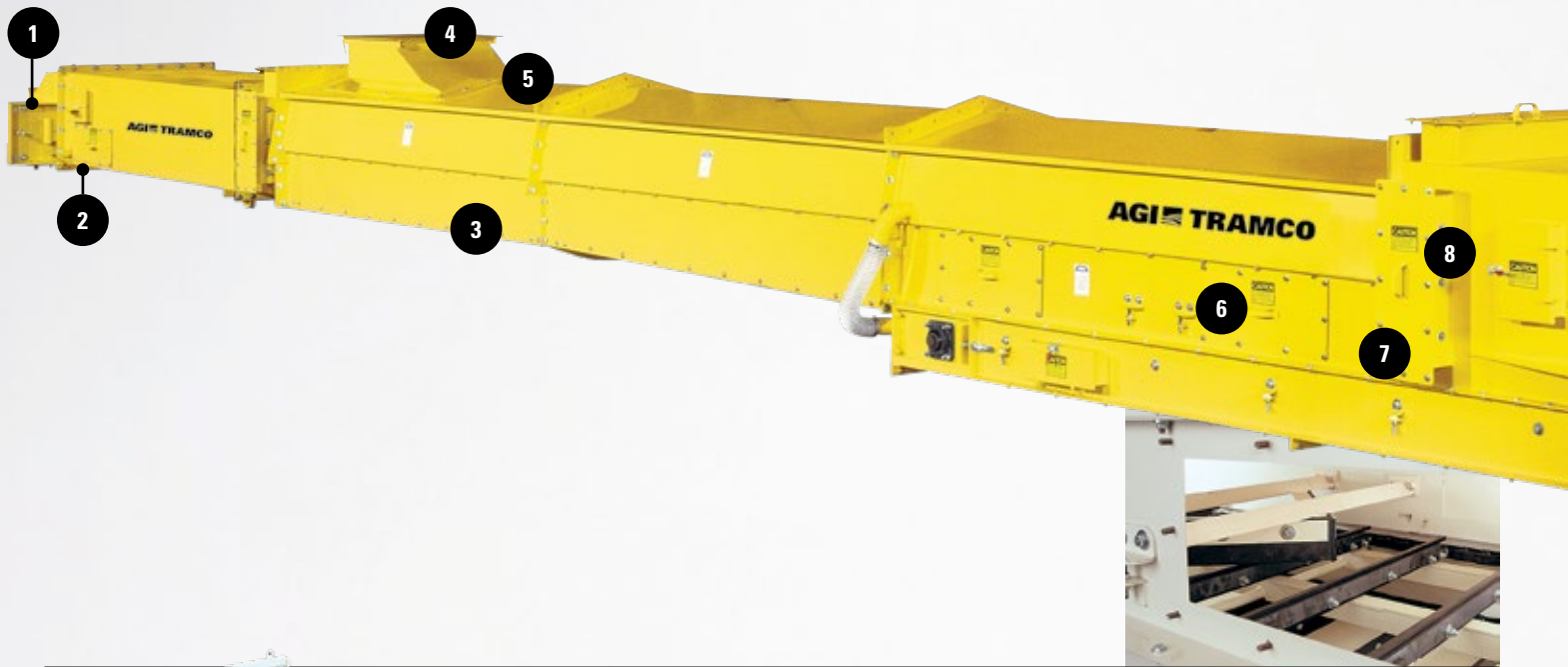

**1**  
Tail section reloading and self-cleaning tail pulley with top hinged access door.

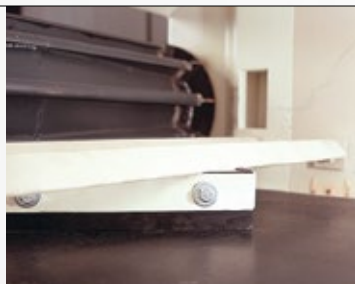

**2**  
V-plow prior to self-cleaning, reloading tail pulley.

**3**  
**Option**  
Inspection door on intermediate return pan

**4**  
Inlet

**5**  
**Option**  
Inspection door on cover

**6**  
V-plow and reloading belt cleaner. Patent Pending. (Belt not shown).

**7**  
Transition Idler Access

**8**  
Adjustable Packing Gland Seal



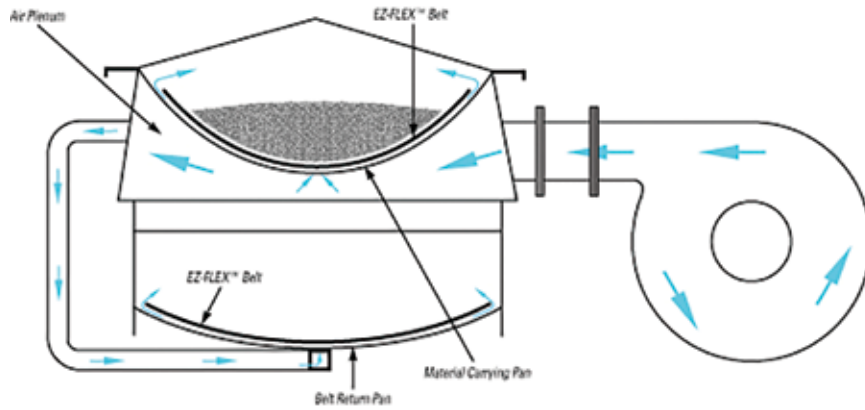

## HERE'S HOW JETBELT™ SYSTEM WORKS

The load-carrying EZ-FLEX™ Belt is supported by a layer of air between the belt and the pan. The air is supplied from a fan, which pressurizes the air chamber under the pan. The air flows up through holes in the pan. The air is then vented to a dust control system. This unique design allows the JetBelt™ to free span 40 feet and greater.

Tramco uses the EZ-FLEX™ Belt exclusively. With unique qualities which include more lateral elasticity in cold climates and the ability to readily conform to the air film between the belt and the conveyor plenum. This is done without compromising longitudinal strength.



**10**  
Head pulley showing  
reloading belt cleaner.



**11**  
Internal view of  
reloading belt cleaner.  
Patent Pending (Belt  
not shown).

**12**  
Discharge 45° or  
90° (90° shown)

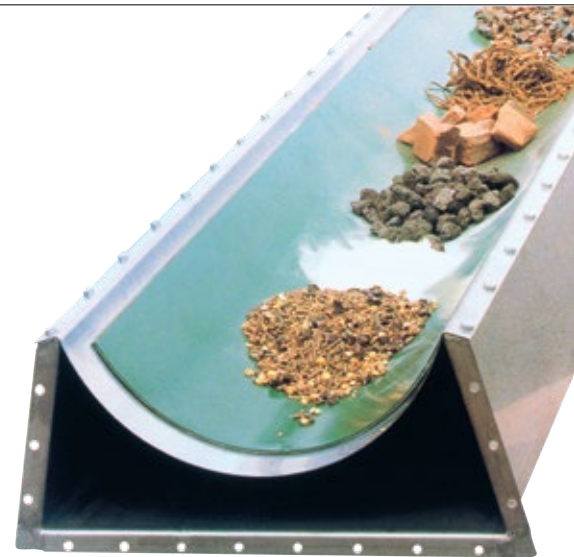

## WITH THE JETBELT™, DRYBULK HANDLING IS A BREEZE!

TRAMCO has been engineering air supported belt systems since the early 1980's and now with state-of-the-art technology, JetBelt™ is the highest performing, best value air conveyor system in the industry.

JetBelt™ offers an entirely new level of operating efficiencies for dry bulk handling requirements such as grain, coal, limestone and aggregates. Instead of relying on conventional roller bearings to support the belt, JetBelt™ rides on a thin "cushion of air" for virtually friction-free operation. Its smooth transport and constant air flow mean materials stay on the conveyor belt and dusting is practically eliminated.

JetBelt™ lets you move the same materials faster, more safely, improves working conditions and provides a dramatic reduction in energy and maintenance costs.

The TRAMCO JetBelt™ is the conveyor system that delivers the most to you and it does it all with air.

# THE WORLD'S MOST COMPLETE LINE OF CHAIN & ENCLOSED BELT CONVEYORS

TRAMCO conveyors and elevators, *The Quiet Ones* (italicize this) have become the standard of the industry. They are designed, engineered and built for hard work and long life. All models feature non-metallic flights for lower noise levels, minimal maintenance and downtime.

**1**

## **TRAMCO BUCKET ELEVATOR**

THE WORK HORSE

Centrifugal Discharge design is used for the bulk handling of free-flowing fine and loose materials with small to medium size lumps. Built-to-last for the toughest requirements.

**2**

## **TRAMCO JETBELT™**

AIR SUPPORTED BELT CONVEYOR

An efficient system requiring less horsepower than other systems. Used for dry bulk handling requirements in a variety of products.

**3**

## **TRAMCO MODEL RB**

Designed for self-cleaning and quiet operation with a u-shaped trough for handling soft stock or materials that are easily crumbled or broken.

**4**

## **TRAMCO MODEL G**

Built standard with 10-gauge construction to accommodate large capacities of free-flowing materials. Provides years of trouble-free service under extreme applications.

**5**

## **TRAMCO BULK-FLO™**

The heavy-duty chain conveyor designed specifically for processing applications such as; wet and sticky, varying sizes and densities and abrasive or corrosive materials.







**Tramco is an AGI Brand.**

AGI is a leading provider of equipment solutions for agriculture bulk commodities including seed, fertilizer, grain, and feed systems with a growing platform in providing equipment and solutions for food processing facilities. AGI has manufacturing facilities in Canada, the United States, the United Kingdom, Brazil, South Africa and Italy and distributes its products globally.

# **AGI** **TRAMCO**

1020 East 19th Street North, Wichita, Kansas USA 67214  
 316.264.4604 | sales@tramcoinc.com | tramcoinc.com

AGGROWTH.COM      @aggrowthintl