

Milling Applications

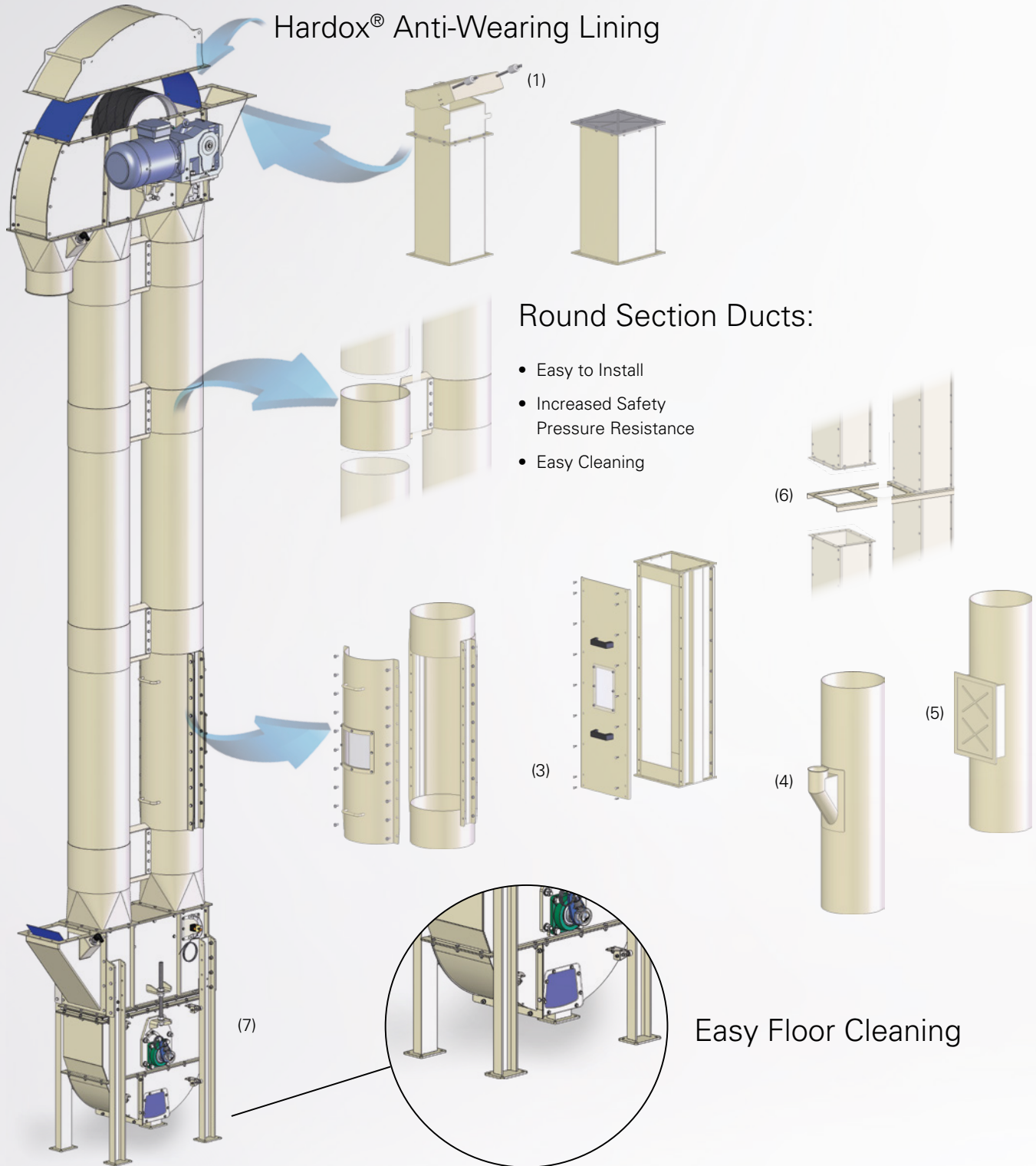

PTM Technology

- Food Grade Painting
- Wide range of machines. Customization according to customer's requirements
- Standard Execution **CE**, or in compliance with ATEX Directive 94/9/CE **Ex**



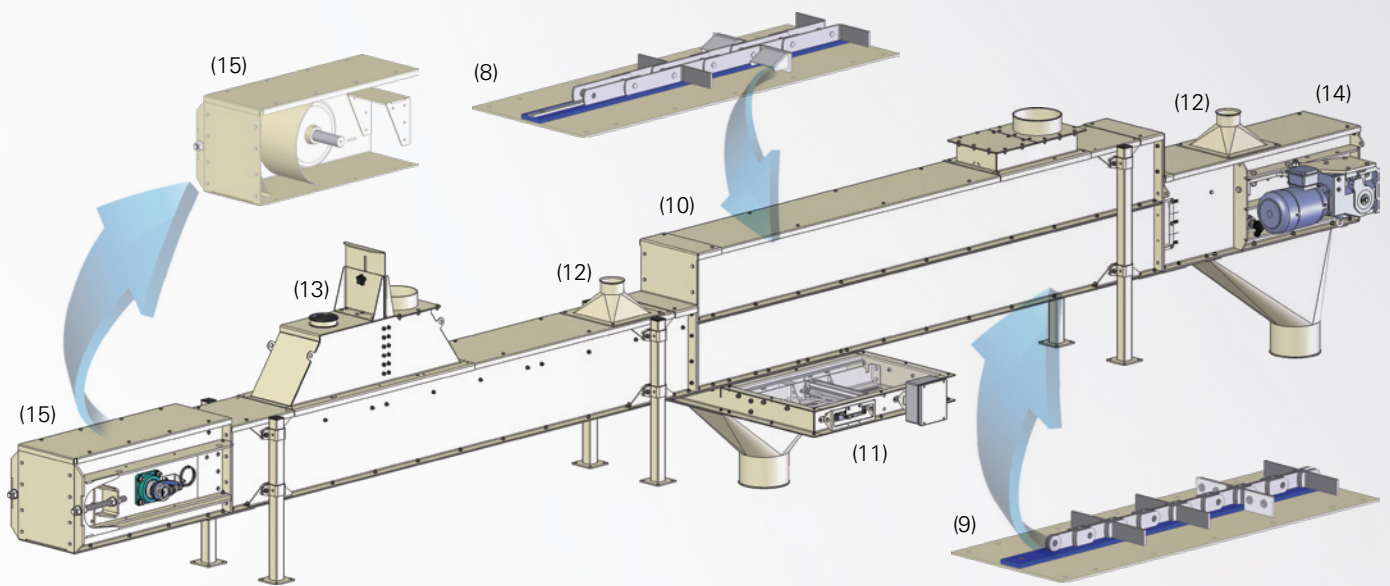

(1) Over Pressure Discharge

(2) Explosion Venting Panel

(3) Inspection Duct

(4) Aspiration Connection

(5) Explosion Venting Panel on Duct

(6) Square Section Ducts:

- Flanged Connections
- Realized in Bolted Panels

(7) Self Cleaning Tail

(8) Bent Links Scraper Chain

(8) Drop Forged Scraper Chain

(10) Double Deck Casings

(11) Slides:

- Pneumatic Control
- Manual Control
- Electric Control

(12) Aspiration Connections

(13) Flow Adjustable Inlet Hoppers

(14) Self Cleaning Driving Head

(15) Self Cleaning Tail



Bucket Elevators

TYPE ETM		
MODEL	CAPACITY ^(*) (TPH)	MAX POWER (kW)
ETM.300	20 ÷ 35	7,5
ETM.400	25 ÷ 100	11
ETM.500	60 ÷ 175	45

^(*) Capacities are referred to dry cereal (r.h. 14%), with bulk density 0,78 t/m³ and impurities lower than 4%

Chain Conveyors

TYPE TCM		
MODEL	CAPACITY ^(*) (TPH)	MAX POWER (kW)
TCM.320.160	40	9,2
TCM.320.200	60	
TCM.400.200	80	30
TCM.400.250	100	
TCM.400.300	120	
TCM.400.350	150	
TCM.400.400	200	

^(*) Capacities are referred to dry cereal (r.h. 14%), with bulk density 0,78 t/m³ and impurities lower than 4%

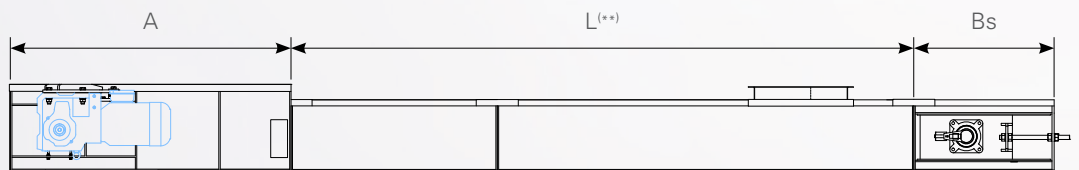
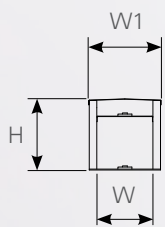
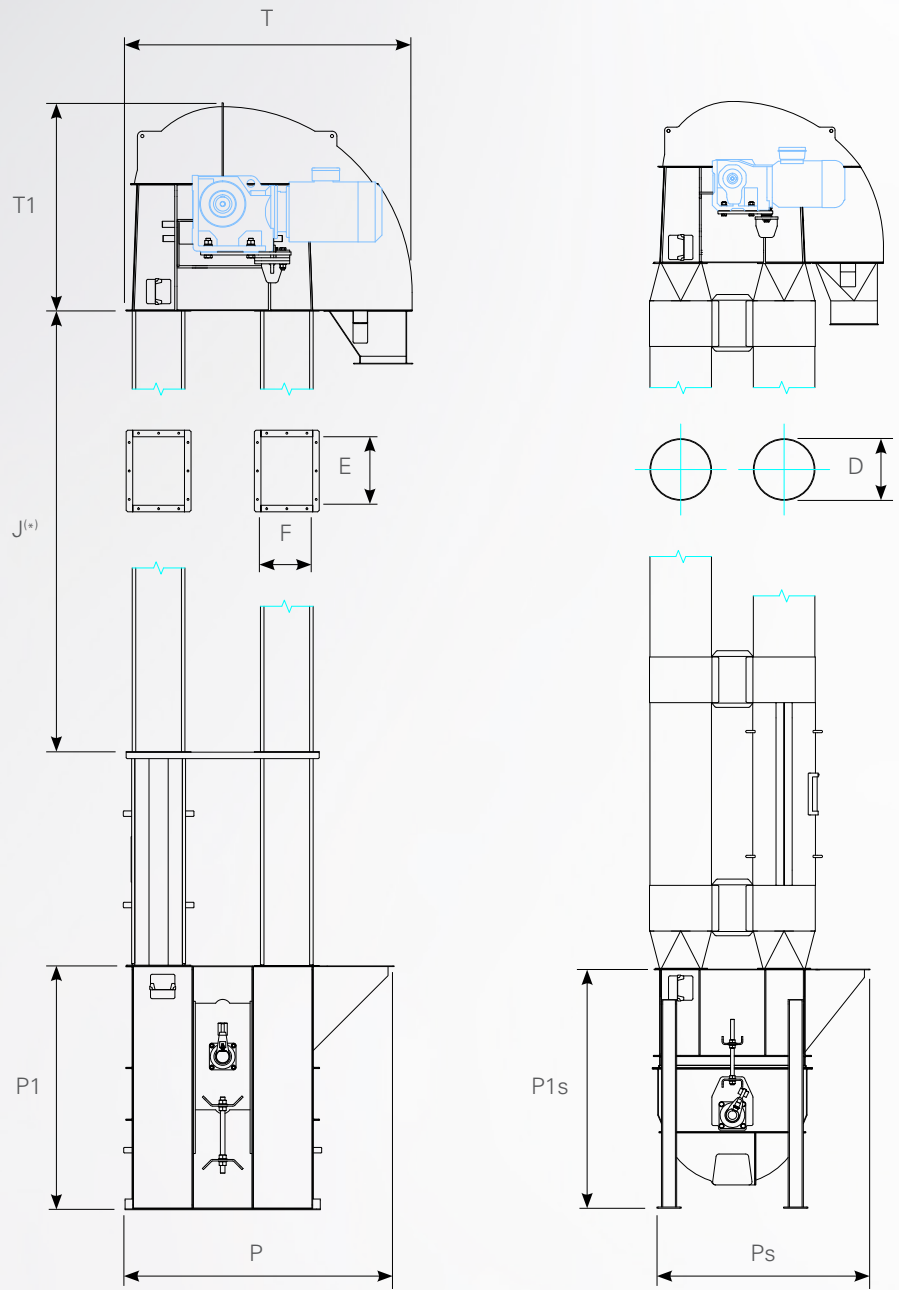

Bucket Elevators
20 ÷ 1200 tph

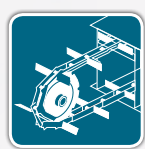

Chain Conveyors
20 ÷ 800 tph



Belt Conveyors
40 ÷ 1600 tph

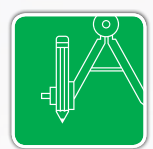

Engineering Turn Key Solutions

Bucket Elevators

TYPE ETM		
MODEL	DIMENSIONS T/T1/T2 (mm)	DIMENSIONS T/P1/E/F Ps/P1/D (mm)
ETM.300	933 / 647 / 345	827 / 715 / 165 / 145 850 / 1100 / 180
ETM.400	1326 / 1038 / 476	1170 / 1000 / 250 / 230 1185 / 1430 / 325
ETM.500	1509 / 1059 / 693	1425 / 1250 / 335 / 269 1400 / 1570 / 404

(*) J = 2900 / 2400 / 1900 / 1400 / 900 / 400 mm
(Special dimensions available upon request)

Chain Conveyors

TYPE TCM		
MODEL	CAPACITY(*) (TPH)	MAX POWER (kW)
TCM.320.160	160 / 230 / 330	1000 / 950
TCM.320.200	200 / 270 / 330	
TCM.400.200	200 / 316 / 420	1250 / 1000
TCM.400.250	250 / 370 / 420	
TCM.400.300	300 / 416 / 420	
TCM.400.350	350 / 465 / 420	
TCM.400.400	400 / 515 / 420	

(**) L = 2970 / 2470 / 1980 / 1470 / 990 / 490 mm (Special dimensions available upon request) - Standard elbow casings (from horizontal to inclined and from inclined to horizontal): 5° - 10° - 15°

As an option the conveyor can be supplied with reinforced steel bottom or with PE-UHMW bottom lining (also food grade type)

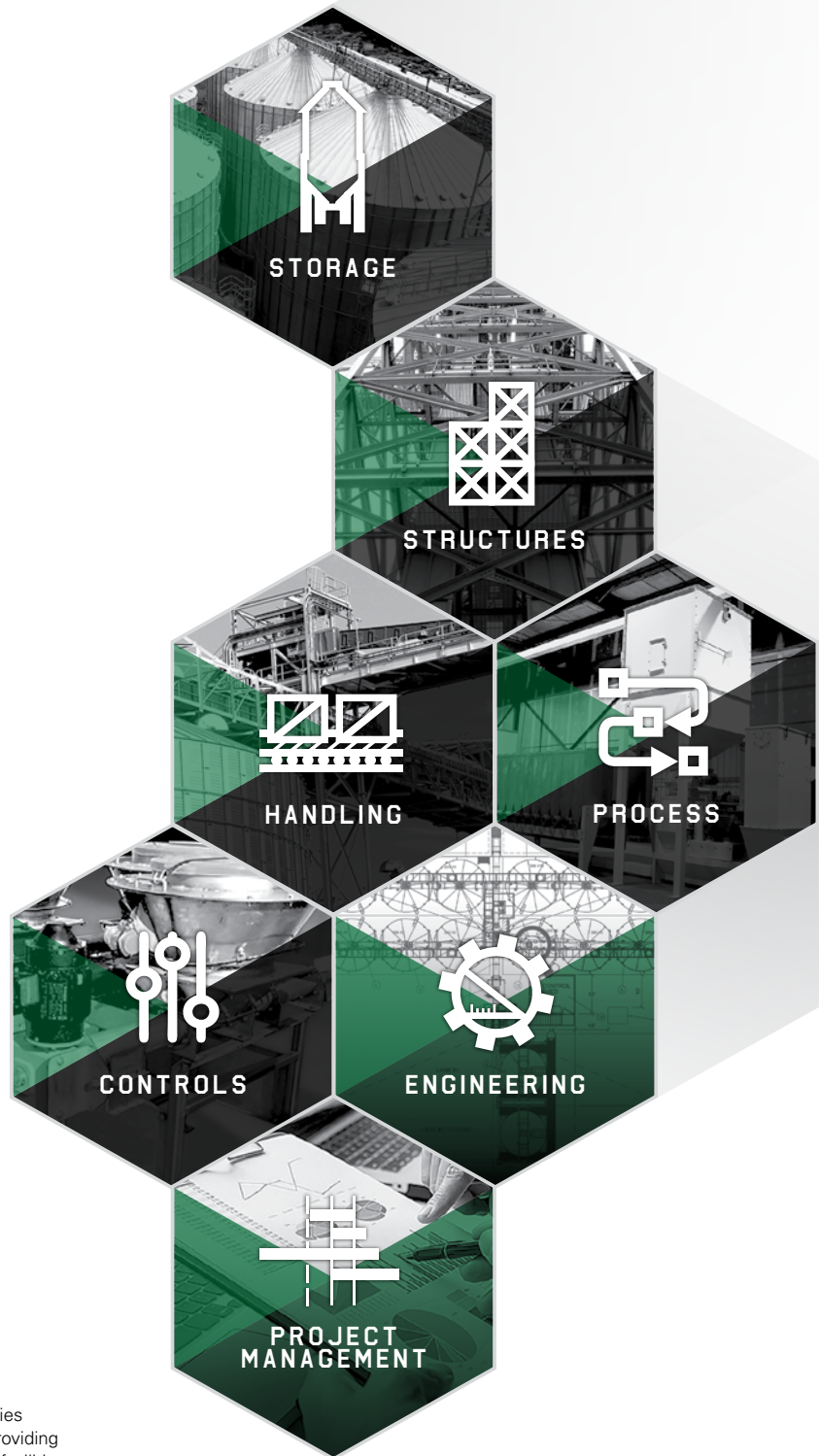

PTM is an AGI Brand.

AGI is a leading provider of equipment solutions for agriculture bulk commodities including seed, fertilizer, grain, and feed systems with a growing platform in providing equipment and solutions for food processing facilities. AGI has manufacturing facilities in Canada, the United States, the United Kingdom, Brazil, South Africa and Italy and distributes its products globally.

AGI  PTM

PT.M. s.r.l. - s.u., Via Mario Tognato, 10, 35042 Este (PD) - ITALY
 +39.0429.600973 | info@ptmtechnology.com | ptmtechnology.com